



Intelligent Thermostat **Product Manual**

151216 v1.3



- Before installing or servicing the thermostat, turn off power to the system at the circuit breaker.
- Leave power off until you have finished installing or servicing.
- Shorting the electric terminals at the control on the heating or cooling system may damage the thermostat. Do not test the system this way.
- You must follow all local codes and ordinances for wiring the system.
- This thermostat should only be powered by 4 AA alkaline batteries or a listed class 2 power supply at 24 VAC (C-Wire or wall transformer).
- An amperage higher than 1 amp to each thermostat relay load may cause damage to the thermostat.
- Verify that the system is 24 VAC. If the old system is labeled as 120 or 240 volts or has wire nuts, the system is high voltage. Do not install the thermostat to a high voltage system. Contact a local HVAC professional for help.

Box Contents:

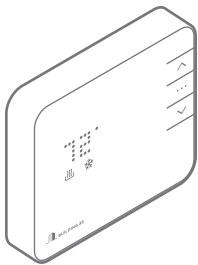

Thermostat

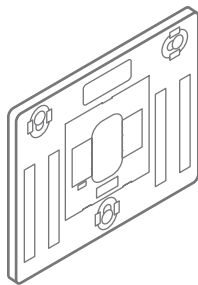

Backplate

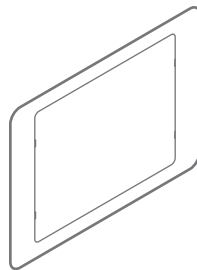

Trim Plate (Optional)

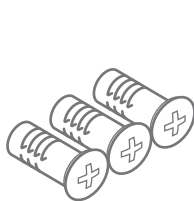

Drywall Screws (3)

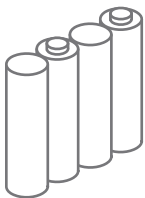

AA Batteries (4)

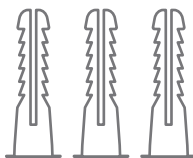

Drywall Anchors (3)

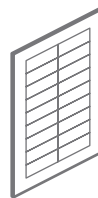

Wire Labels

Recommended Tools:

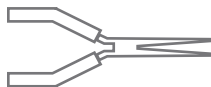

Needlenose Pliers



Phillips Head
Screwdriver

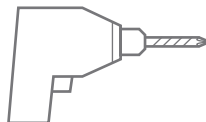

Power Drill



Pencil

Thermostat Overview

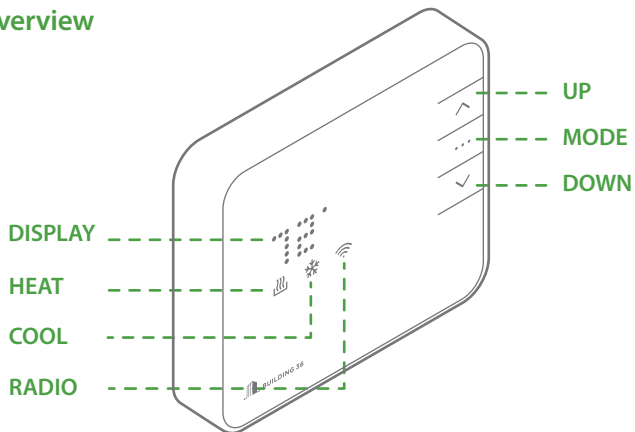

Buttons

- **UP** (↗) Button – Adjust target temperature up.
- **MODE** (•••) Button – Change thermostat between HEAT, COOL, AUTO, and OFF modes.
- **DOWN** (↘) Button – Adjust target temperature down. Also used to include and exclude from the network.

Icons

- **HEAT** (🔥) Icon – Illuminated in HEAT or AUTO mode.
- **COOL** (❄️) Icon – Illuminated in COOL or AUTO mode.
- **RADIO** (📶) Icon – Illuminated during the wireless configuration.

Modes

- **AUTO:** **HEAT** (🔥) Icon and **COOL** (❄️) Icon Illuminated at the same time. The thermostat will automatically select the appropriate mode.
- **OFF:** No icons will be illuminated. The system will not heat or cool when in OFF mode.

Location

If replacing an old thermostat, the new thermostat can be mounted in its place.

If a new location is desired it will be necessary to move the wiring.

New installations and relocation should follow the accompanying guidelines to ensure the most accurate temperature reading and ease of use.

- Mount thermostat on an inside wall, approximately 5 ft. (1.5m) above the floor in a frequently used room.
- Do not install in locations near appliances or devices that affect the local temperature such as televisions, lamps, or dryers.
- Avoid areas that are exposed to large temperature variances, such as: direct sunlight, near an AC unit, above or below auxiliary heat and air vents, and drafts from windows.
- Be aware of what is on the other side of the wall where the thermostat is being installed. Do not install on walls adjacent to unheated rooms, stoves, or housing hot water pipes.
- Damp areas will not only affect the humidity reading of the thermostat, but could lead to corrosion and shorten the life of the thermostat.
- Install in a location with good air circulation. Stagnant air will not accurately reflect the rate of temperature change in the room. Avoid areas behind open doors, corners, and alcoves.
- Wait until construction and painting are finished before installing.

Preparation

The Existing Thermostat

1. Test the System

Verify that the heating and/or cooling system is operating properly before you try to install the new thermostat.

DO NOT test the system by shorting electric terminals at the furnace or air conditioner. This may damage the thermostat.

2. Turn Power Off

- Turn all heating and cooling systems off. This can be done at the circuit breaker.

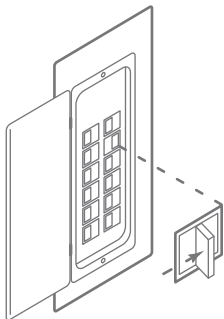

CAUTION: DO NOT REMOVE the existing thermostat until power has been turned off at the circuit breaker.

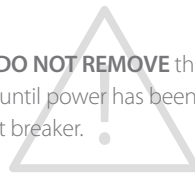

Once power to the heating AND cooling systems is off, follow these steps:

3. Remove Thermostat Cover

- Remove the cover from the existing thermostat. **Do not disconnect the wires yet.**

TIP: Take a picture of the wires before you detach them from the existing thermostat for future reference.

4. Label All Existing Wires

- Label all existing wires, one at a time, with the labels provided.

Make sure the wires are labeled correctly. If you have an unidentified wire, it may be necessary to identify the wire where it connects to the heating or air conditioning equipment.

TIP: Take another picture of the wires to document connections for easy reference. Do not disconnect wires before labeling them.

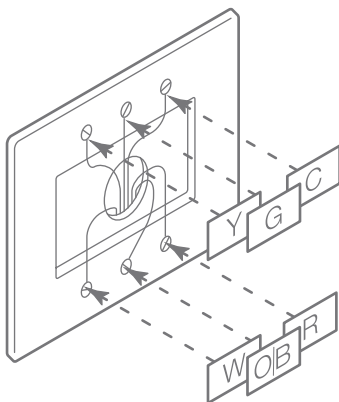

CAUTION: Wiring can vary for each manufacturer. Label all wiring before removing it from the existing thermostat.

- Disconnect all of the wires and remove the existing thermostat.

TIP: Remember to secure the wires so they don't fall into the wall.

Prepare the Wires

Follow these guidelines for safe and secure wire connections:

- Ensure the wires are a proper gauge between 18-24 AWG.
- Make sure wires have exposed straight ends about 1/8" long.

CAUTION: Verify that the system is 24 VAC. If the old system is labeled as 120 or 240 volts or has wire nuts, the system is high voltage. Do not install the thermostat to a high voltage system. Contact a local HVAC professional for help.

Install Your New Thermostat

Install the Back Plate

Use the bubble level provided on the back plate as a guide. Mark where the screws will go with a pencil through the screw holes on the back plate.

TIP: If necessary, use the trim plate to cover up any marks or holes left from the old thermostat. Attach the trim plate before securing the back plate to the wall.

TIP: Drill holes with 3/16" drill bit to tap in the drywall anchors for added support.

Wire Your New Thermostat

Reconnect the wires to the new thermostat and indicate the connected wires with a pencil in the image below. This information will be needed when configuring the thermostat.

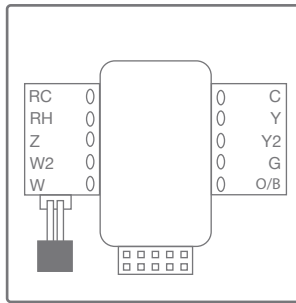

TIP: If you have extra wires do not install them in the new thermostat. Please contact your local HVAC professional for additional assistance.

- If you have R, connect it to RH.
- If you have RH & RC, remove the black jumper in the lower left corner of the back plate terminal board with needlenose pliers.

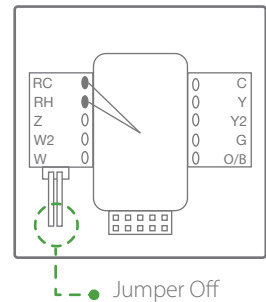
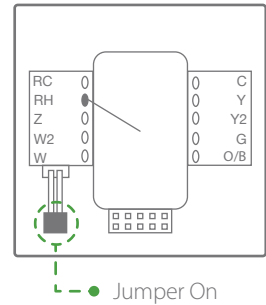

- Z can be used for W3 or O/B Zoning

Thermostat Wire Terminals

W – 1st Stage Heat / 1st Stage Auxiliary Heat (Heat Pump)

W2 – 2nd Stage Heat / 2nd Stage Auxiliary Heat (Heat Pump)

Y – 1st Stage Cool / 1st Stage Heat Pump (On during heating and cooling)

Y2 – 2nd Stage Cool / 2nd Stage Heat Pump (On during heating and cooling)

G – Fan (used with Conventional Electric Heat, Heat Pump, AC, Stand-alone Air Handler)

Z – 3rd Stage Heat / 3rd Stage Auxiliary Heat / OB Zoning

O/B – Heat Pump Reversing Valve (O – cooling, B – heating)

Insert Batteries Into the Thermostat

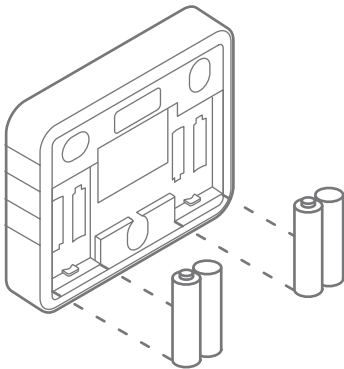

The thermostat can be powered by battery or 24 VAC. If a wall transformer is used to power the thermostat, connect between C and RH.

Ensure the batteries are installed following the specified polarity markings on the thermostat.

CAUTION: Special Battery Warning

- Always replace the batteries as soon as you have low battery levels, indicated by “LOW” then “BATT” flashing on the display. If the batteries drain, the thermostat could leave the HVAC system on, overheating or freezing the home.
- Always replace the batteries at least once a year. This will protect the thermostat from damage and corrosion by leaking batteries.
- If the home is unoccupied for a month or more, such as vacation homes, you should replace the batteries as a preventive measure against battery failure while you are away.
- Always use new batteries as replacements.

Install Thermostat Body to Back Plate

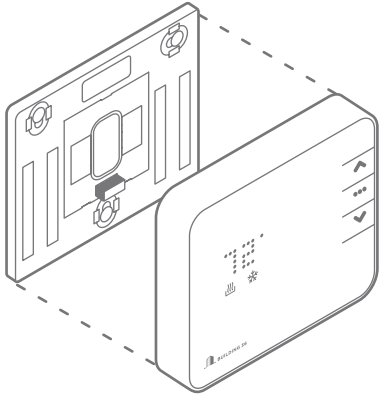

Verify that any excess wire is tucked back into the wall to allow room for the thermostat to sit flush against the back plate.

Press the thermostat body firmly into the back plate mounted to the wall. Ensure that the pins on the body are correctly aligned with the header attached to the terminal board on the back plate. Failure to do so could cause damage to the thermostat.

Turn the Power On

Restore power to all the heating and cooling systems. This can be done at the circuit breaker.

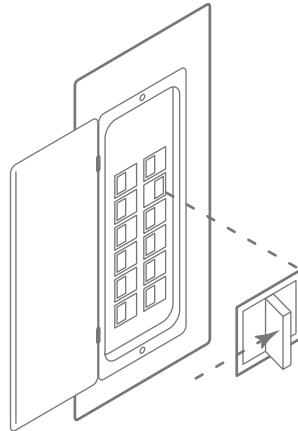

Connect the Thermostat to the System

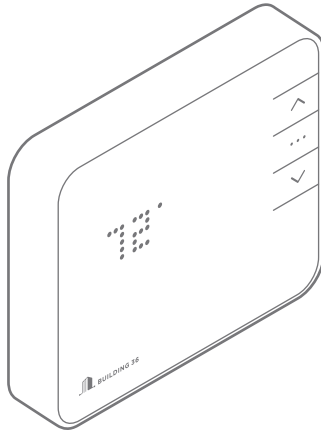

1. Put the thermostat in **OFF** mode (No mode icons are lit).
2. Put the Z-Wave controller into inclusion mode. Refer to the controller documentation for more information.
3. Press and hold the **DOWN** (✓) button on the thermostat to begin inclusion mode. Release the button when the **RADIO** (📶) icon lights up.
4. When the **RADIO** (📶) icon becomes solid, the thermostat has been included.
5. Login to your online account (www.Building36.com/login) to sync the thermostat with the Building 36 system, or contact a Building 36 professional for installation setup.

Write your login information below once you have chosen a personal password.

User ID: _____ Password: _____

Configure the System

The thermostat configuration will be done on your online account. Here you can configure the parameters of the system, such as: Heat Pump or Normal, number of heat and cool stages, heating fuel, calibration temperature, and configurable terminal (Z). In your online account, you will have to enter the thermostat configuration. Refer to page 9 for the appropriate diagrams when you set up the thermostat.

While the default settings will be sufficient in most cases, you also have the option to change advanced configuration settings, such as: Swing, Differential, Recovery Settings, Fan Circulation Period and Duty Cycle, Maximum Set Points, Minimum Set Points and Thermostat Lock.

WARNING: Use caution when changing advanced configuration settings. These configuration settings should only be changed by those familiar with heating and cooling systems' parameters. Contact a local HVAC professional for help.

Check the System

WARNING: Do not test the AC during cold weather or heat during hot weather. Wait for mild weather to fully test the system.

To Check Heating

1. Press the **MODE** (•••) button to select **HEAT** (☀️) mode.
2. Press the **UP** (⤴️) button to raise the set point above room temperature.
3. Wait 5 minutes for the system to turn on.
4. After verifying the heating system is working, return the set point to the desired temperature.

To Check Cooling

1. Press the **MODE** button (•••) to select **COOL** (❄️) mode.
2. Press the **DOWN** (⤵️) button to lower the set point below room temperature.
3. Wait 5 minutes for the system to turn on.
4. After verifying the cooling system is working, return the set point to the desired temperature.

Operation

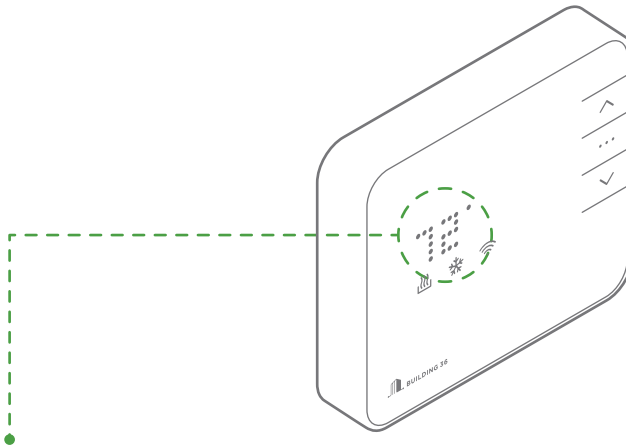

Display

1. Press any button to wake the thermostat up.
2. After waking, the display will show the current mode and room temperature.
3. Press the **UP** (∧) or **DOWN** (∨) button once to display the current set point.
 - *The mode icon **HEAT** (≡) or **COOL** (❄) will begin to pulse.*
4. Press the **UP** (∧) or **DOWN** (∨) button again to adjust to the desired set point.

5. Press the **MODE** (•••) button at any time to change the mode.

• *The modes are **HEAT** (≡), **COOL** (❄), **AUTO**, and **OFF**.*

- In **AUTO**, the brighter icon will indicate which set point is currently displayed and active **HEAT** (≡) or **COOL** (❄).
- After 5 seconds the display will return to the current room temperature. The mode icon will become solid to indicate this. After 5 more seconds the display will turn off to conserve energy. The thermostat will continue to operate while the display is off.

Troubleshooting

Manual Configuration of HVAC System on Thermostat

If necessary, the system type (Normal or Heat Pump) can be physically set on the thermostat by doing the following:

1. Put thermostat in **OFF** mode.
2. Press and hold the **UP** (∧) button for 5 seconds until the display shows a version number.
3. Press and hold the **UP** (∧) button again for 5 seconds until the display shows your HVAC setup.
4. Press the **UP** (∧) or **DOWN** (∨) buttons to select the thermostat configuration.

CONFIGURATION	SYSTEM TYPE
NORM	Normal 2-Heat 2-Cool System
FOSL	Fossil 2-Heat 2-Cool System (for hydronic heat w/ no fan)
PUMP	Heat Pump (O terminal)
PMPB	Heat Pump (B terminal)
DUAL	Dual Fuel System (O terminal)
DULB	Dual Fuel System (B terminal)

5. Press the **MODE** (•••) button to confirm your selection.

Heating or Cooling Doesn't Turn On When the Set Point is Above or Below the Room Temperature

To prevent damaging the compressor, the thermostat inserts a delay when cycling the compressor. If you think the system should be on and it's not, then change the set point to be 2 degrees beyond the current set point and wait 5 minutes to see if the system turns on. If not, contact a local HVAC professional.

Heat Pump is "Cooling When it Should be Heating" or "Heating When it Should be Cooling"

Because both types of heat pump reversing valves share a single terminal on your thermostat back plate, you need to be sure you have the thermostat configured for the correct wire. Try switching the O/B configuration setting through your online account. Contact a local HVAC professional for further help with this issue.

Exclude the Thermostat From the Z-Wave Network

If for some reason the thermostat must be excluded from the network, follow the steps below to do so.

1. Set the thermostat to **OFF** mode.
2. Press and hold the exclusion button on the Z-Wave controller. Refer to controller documentation for more information.
3. Press and hold the **DOWN** (∨) button on the thermostat to enter exclusion mode. Release the button when the **RADIO** (📶) icon lights up.
4. When the **RADIO** (📶) icon becomes solid the thermostat has now been successfully excluded from the network.

Batteries Drain Quickly

If a thermostat is included using a “C” Wire, that information is saved in the network and cannot be changed unless excluded and included again without a “C” Wire connected. The same applies to thermostats included on battery power.

If you find your thermostat batteries are draining unusually fast, make sure the “C”-Wire connection is still intact. If a device is included using the “C” Wire, the Z-Wave communication never sleeps, and the thermostat will act as a repeater, sending messages for other devices as well. If the “C” Wire is removed, this kind of activity will drain the battery very quickly.

For more help contact your Building 36 Service Provider.

Notices

FCC NOTICE:

This device complies with part 15 of the FCC Rules. Operation is subject to the following two conditions:

1. This device may not cause harmful interference.

–AND–

2. This device must accept any interference received, including Interference that may cause undesired operation.

This equipment has been tested and found to comply with the limits for a Class B digital device, pursuant to part 15 of the FCC Rules. These limits are designed to provide reasonable protection against harmful interference in a residential installation. This equipment generates, uses and can radiate radio frequency energy and, if not installed and used in accordance with the instructions, may cause harmful interference to radio communications. However, there is no guarantee that interference will not occur in a particular installation. If this equipment does cause harmful interference to radio or television reception, which can be determined by turning the equipment off and on, the user is encouraged to try to correct the interference by one or more of the following measures:

- Reorient or relocate the receiving antenna.
- Increase the separation between the equipment and receiver.
- Connect the equipment into an outlet on a circuit different from that to which the receiver is connected.
- Consult the dealer or an experienced radio/TV technician for help.

Notices

IC NOTICE:

Under Industry Canada regulations, this radio transmitter may only operate using an antenna of a type and maximum (or lesser) gain approved for the transmitter by Industry Canada. To reduce potential radio interference to other users, the antenna type and its gain should be so chosen that the equivalent isotropically radiated power (e.i.r.p.) is not more than that necessary for successful communication.

Conformément à la réglementation d'Industrie Canada, le présent émetteur radio peut fonctionner avec une antenne d'un type et d'un gain maximal (ou inférieur) approuvé pour l'émetteur par Industrie Canada. Dans le but de réduire les risques de brouillage radioélectrique à l'intention des autres utilisateurs, il faut choisir le type d'antenne et son gain de sorte que la puissance isotrope rayonnée équivalente (p.i.r.e.) ne dépasse pas l'intensité nécessaire à l'établissement d'une communication satisfaisante.

NOTE: THE GRANTEE IS NOT RESPONSIBLE FOR ANY CHANGES OR MODIFICATIONS NOT EXPRESSLY APPROVED BY THE PARTY RESPONSIBLE FOR COMPLIANCE. SUCH MODIFICATIONS COULD VOID THE USER'S AUTHORITY TO OPERATE THE EQUIPMENT.

